

# **PROMOTECH<sup>®</sup>**



## **PRO-2 PB Product Update**

**DISTRIBUTOR INFO SEPTEMBER/2022**

**HOLEMAKING | BEVELING | WELDING | CUTTING**

## PRO-2 PB – Product Update

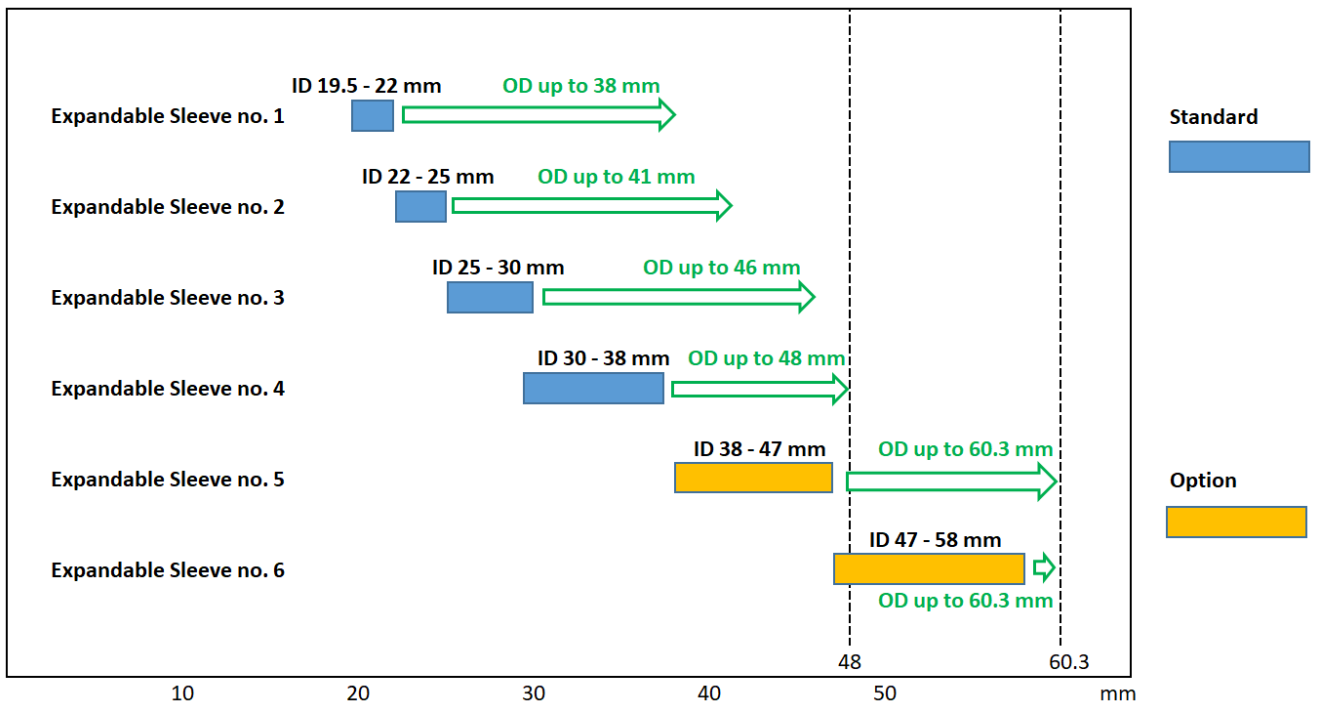
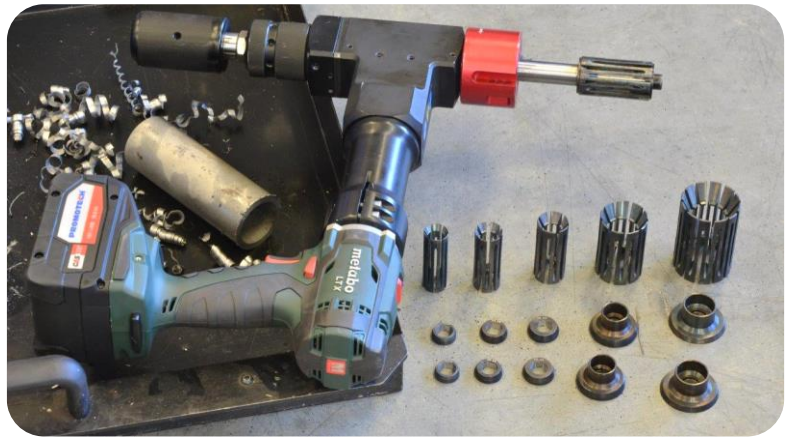

Based on feedback from our customers we have introduced 6 new expandable sleeves that facilitate mounting the mandrel inside the pipe and make the preparation of PRO-2 PB to work much faster and easier.

The sleeves have replaced former jaws, jaw blocks and springs in standard and extension sets.





<p>Max wall thickness up to 8 mm (0.32")</p>	<p>ID 19.5 - 38 mm (0.77 - 1.50") ID 15.5 - 22 mm (0.61 - 0.87") /option/ ID 38 - 58 mm (1.50 - 2.28") /option/</p>	<p>Facing off</p>	<p>Pipe OD beveling up to 48 mm (1.89") up to 60.3 mm (2.37") /option/</p>
--	---	-------------------	--

The implementation of new expandable sleeves resulted in a number of changes in both the PRO-2 PB specification and its standard and optional equipment (see below).

FORMER PRO-2 PB	NEW PRO-2 PB
 <p>Product Code: UKS-0567-10-00-00-0</p>	 <p>Product Code: UKS-0731-10-00-00-0</p>

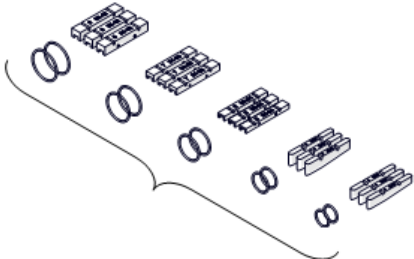
FORMER PIPE DIAMETER	NEW PIPE DIAMETER
<p>22 mm ID – 48 mm OD <i>with standard mandrel set</i></p> <p>15.5 mm ID – 30 mm OD <i>with an optional small mandrel set</i> Product Code: ZST-0567-20-00-00-0</p> <p>42 mm ID – 60.3 mm OD <i>with an optional extension set</i> Product Code: ZST-0567-21-00-00-0</p>	<p>19.5 mm ID–48 mm OD <i>with standard mandrel set</i></p> <p>15.5 mm ID–29 mm OD <i>with an optional small mandrel set</i> Product Code: ZST-0731-03-00-00-0</p> <p>38 mm ID–60.3 mm OD <i>with an optional extension set</i> Product Code: ZST-0731-02-00-00-0</p>

FORMER EQUIPMENT IN SHIPPING SET	NEW EQUIPMENT IN SHIPPING SET
<p>2 sets of jaws (no. 4, 5), 3 sets of jaw blocks (no. 6, 7, 8) and 5 sets of springs (no. 4, 5, 6, 7, 8) for former standard mandrel</p> 	<p>4 expansion sleeves together with 4 sets of spreaders for new standard mandrel</p>  <p>6 mm hex wrench, 19 mm flat wrench</p>

## FORMER STANDARD MANDREL



### ATTENTION:

For those owners of the previous PRO-2 PB machine, who would like to use the current method of fixing inside the pipe, we can offer a special upgrade kit, as shown below.

Product Code: ZST-0731-99-00-00-0



## NEW STANDARD MANDREL

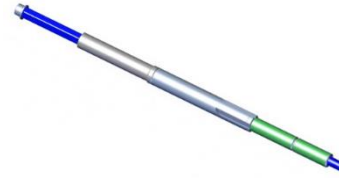

The new standard mandrel allows for a new method of fixing inside the pipe using expansion sleeves and spreaders.

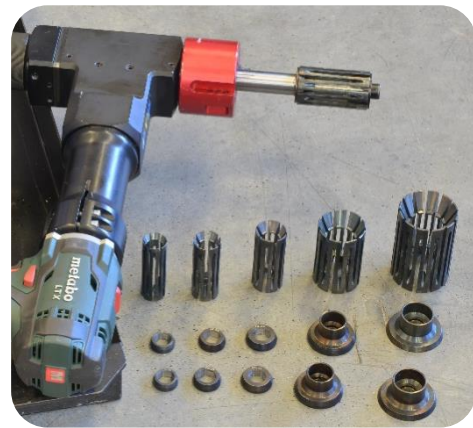

## FORMER SMALL MANDREL SET (OPTION)





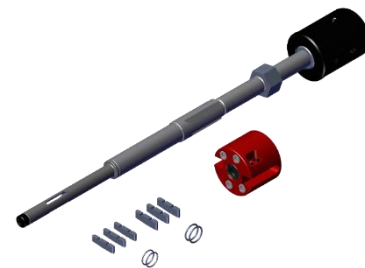

Product Code: ZST-0567-20-00-00-0

## NEW SMALL MANDREL SET (OPTION)

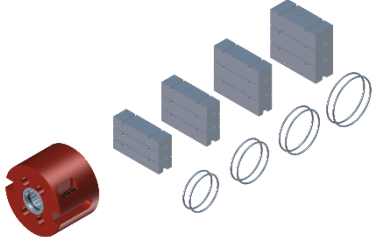





Product Code: ZST-0731-03-00-00-0

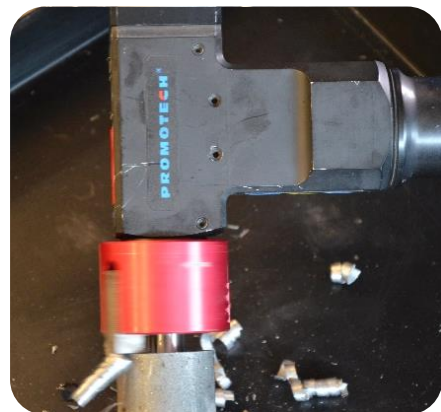
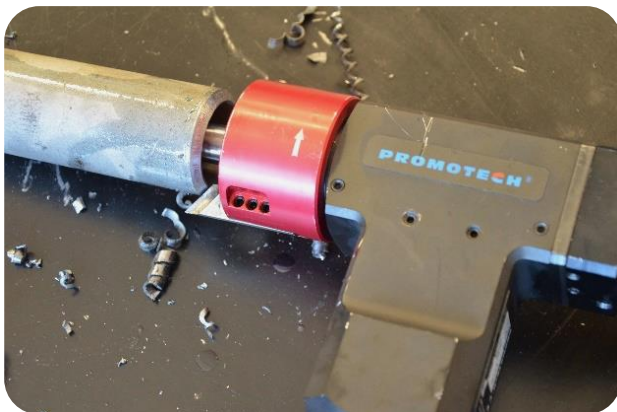

FORMER EXTENSION SET (OPTION)	NEW EXTENSION SET (OPTION)
 <p data-bbox="183 728 630 757">Product Code: ZST-0567-21-00-00-0</p>	 <p data-bbox="845 728 1292 757">Product Code: ZST-0731-02-00-00-0</p>

FORMER BATTERY DRIVE	NEW BATTERY DRIVE (BRUSHLESS)
 <p data-bbox="183 1366 534 1395">Product Code: WRT-000021</p>	 <p data-bbox="710 1153 1061 1182">Product Code: WRT-000024</p> <div data-bbox="922 1321 1433 1473" style="border: 1px solid black; padding: 5px; margin-top: 20px;"> <p><b>ATTENTION:</b> Driver remains the same as before. Product Code: ZBI-0567-26-00-00-0</p> </div> 



FORMER BATTERY PACK	NEW BATTERY PACKS
 <p>Battery Li-Power Product Code: AKM-000088</p>	<p>Battery LiHD 4.0 Ah Product Code: AKM-0738-10-00-01-0</p>  <p>Battery LiHD 5.5 Ah Product Code: AKM-0738-10-00-03-0</p>  <p>Battery LiHD 10.0 Ah Product Code: AKM-0738-10-00-02-0</p> 



FORMER BATTERY CHARGER	NEW BATTERY CHARGER
 <p>Product Codes: LDW-000008 (230 V CEE) LDW-000010 (120 V UK) LDW-000011 (230 V AU)</p>	 <p>It features patented Air-Cooled charging technology that enables the hot battery to be placed on the charger immediately. The charger's built-in Air-cooled system quickly cools the battery as the pack begins its charging cycle</p> <p>Product Codes: LDW-0738-10-00-30-0 (EU) LDW-0738-04-00-30-0 (UK) LDW-0738-06-00-30-0 (AUS/NZ)</p>

**ATTENTION :** *New charger and all LiHD battery packs (4.0, 5.5 and 10.0 Ah) are suitable for both **PRO-2 PB** and **PRO-5 PB** pipe bevellers.*



**PRO-2 PB**



**PRO-5 PB**

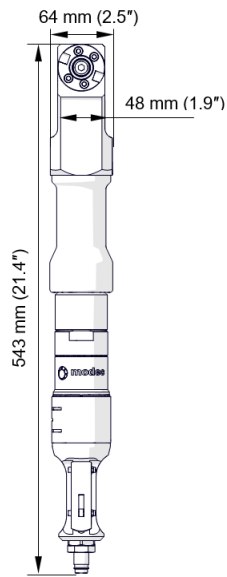
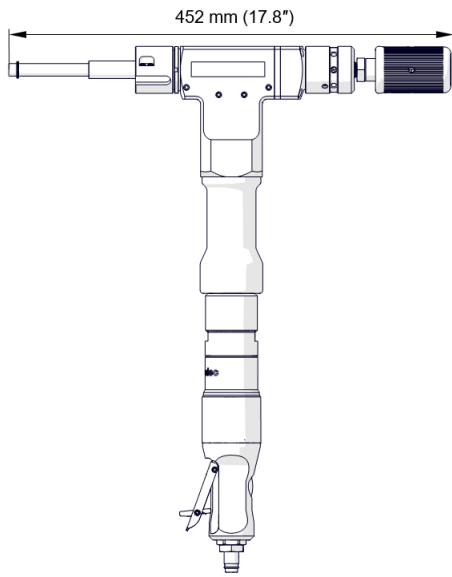

**PRO-2 PB with  
pneumatic motor**

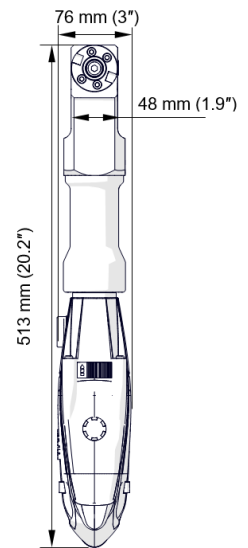
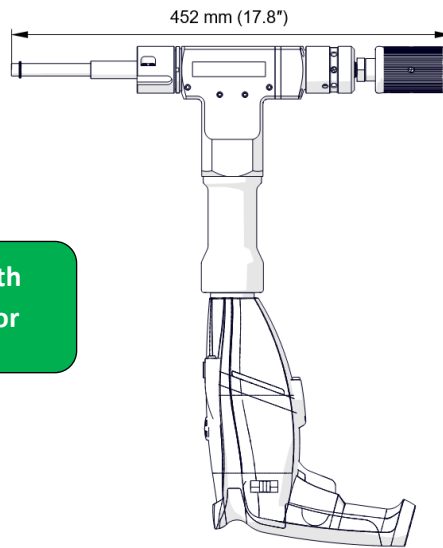

**PRO-2 PB with  
electric motor**

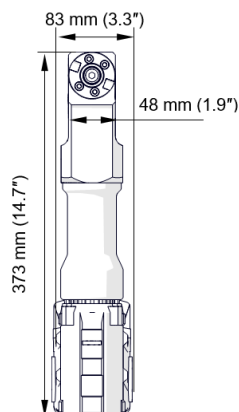
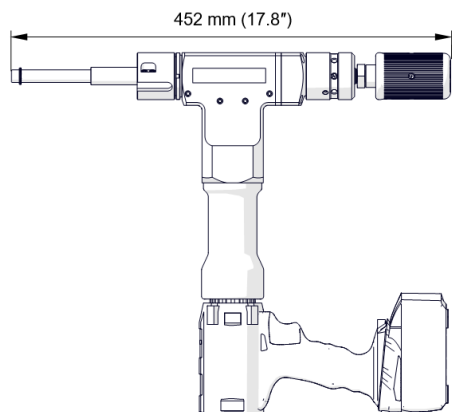

**PRO-2 PB with  
battery drive**